



## TRANSFORMER SPECIFICATION

- 3 Phase Drive Isolation
- Dry Type
- ANN Self Cooled
- Suitable for nonsinusoidal Current Load with a K-Factor not to exceed 4

Purchaser: TBA  
 PO#: TBA  
 SWO#: TBA  
 Qty: TBA

Coils: Aluminum  
 Cat. No.: DA27X-P/FE  
 RPN#: DA27HCB-P/X/FE

kVA: 27  
 Primary: 480/240/208 Delta Volts  
 Secondary: 480 Y/277 Volts  
 Secondary Taps: 5 %  
 -Taps FCAN 1  
 -Taps FCBN 1

Frequency: 60 Hz

BIL: 10 kV  
 Insulation Class: 220 °C  
 Temperature Rise: 150 °C  
 Impedance: 4.5 - 5.5 %

Weight: 315 Lbs

Termination	Location	Lug Size
Primary:	Front	2-14 AWG
Secondary:	Front	2-14 AWG

### Wiring Connection:

#### Primary:

Voltage	Jumpers To:	Connect Lines To:
480	1-1-1	H1-H2-H3
240	2-2-2	H1-H2-H3
208	3-3-3	H1-H2-H3

#### Secondary:

Voltage	% Tap	Connect Loads To:
504Y/291	105.0	X0-X7-X8-X9
480Y/277	100.0	X0-X4-X5-X6
456Y/263	95.0	X0-X1-X2-X3

**Note:** Secondary is fully rated - only one can be used at a time

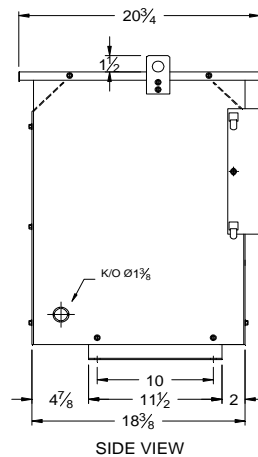
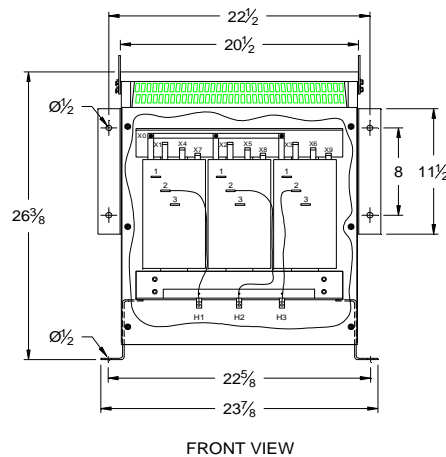

## Preliminary Drawing ONLY

This drawing may NOT truly reflect our final design. Any resulting order(s) must be accompanied by or refer to this drawing and be marked with any proposed changes

### Standards:

1. CSA Certified
  - File No. LR34493
2. UL Listed
  - File No. E108255

### Standard Features:

1. Anti-vibration pads installed between the enclosure base and the core & coil assembly
2. Lug for Earth grounding provided
3. Neutral rated 200% of the line terminals
4. NC 200°C thermostat installed at the centre coil

### Special Features:

± 5% F.C. Secondary taps

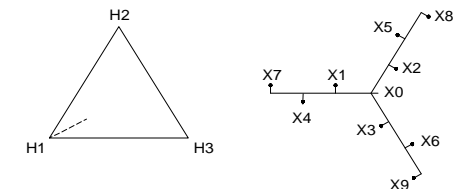

### CSA Enclosure:

1. Type 3R (NEMA 3R)
  - Sprinklerproof when the angle between sprinkler heads and opening in the enclosure does not exceed 45 degree from the vertical.
2. Ventilated
3. ASA 61 grey
4. Floor/Wall mounting

Rev.	Remarks	By	Appr. By	Date

Prepared by: AP

Approved by: VS

Date: JUNE 8, 2015