



Don't Buy A Transformer
Until You Call FARGO!
www.FargoElectric.com
email: Sales@FargoElectric.com
tel: (716) 741-0035
fax: (716) 741-3033
Fargo Electric Inc.
10205 Lapp Road
Clarence Center, NY 14032

TRANSFORMER SPECIFICATION

- 3 Phase Drive Isolation
- Dry Type
- ANN Self Cooled
- Suitable for Nonsinusoidal Current Load with a K-Factor not to exceed 4

Drawing for Record

This drawing is a record of our final design for the noted order number.

Coils: Aluminum
Cat. No.: DA63X-MFE
RPN#: DA63HCB-M/X/FE

kVA: 63
Primary: 480/240/208 Delta Volts
Secondary: 208 Y/120 Volts

Secondary Taps: 5 %
-Taps FCAN 1
-Taps FCBN 1

Frequency: 60 Hz

BIL: 10 kV
Insulation Class: 220 °C
Temperature Rise: 150 °C
Impedance: 4.0 - 5.0 %

Weight: 560 Lbs

Purchaser: TBA
PO#: TBA
SWO#: TBA
Qty: TBA

Windings	For Cable Size	Lugs Terminations
Primary @ Front	#6 AWG up to 300MCM	300MCM-6 (1/Ph)
Secondary @ Front	#6 AWG up to 300MCM	300MCM-6 (1/Ph)
Ground lug @ the base of enclosure		2-14 AWG

Wiring Connection:

Primary:

Voltage	Jumpers To:	Connect Lines To:
480	1-1-1	H1-H2-H3
240	2-2-2	H1-H2-H3
208	3-3-3	H1-H2-H3

Secondary:

Voltage	% Tap	Connect Loads To:
218Y/126	105.0	X0-X1-X2-X3
208Y/120	100.0	X0-X4-X5-X6
198Y/114	95.0	X0-X7-X8-X9

Note: Secondary is fully rated - only one can be used at a time

Standards:

- 1)- CSA Certified File No. LR34493
- 2)- UL Listed File No. E108255

Standard Features:

- 1)- Anti-vibration pads installed between the enclosure base and the core & coil assembly
- 2)- Lug for Earth grounding provided
- 3)- Neutral rated 200% of the line terminals
- 4)- N/C 200°C thermostat installed at the centre coil
- 5)- Seismic rated for USA zone 4 and Canada zone 6

Special Features:

± 5% F.C. Secondary taps

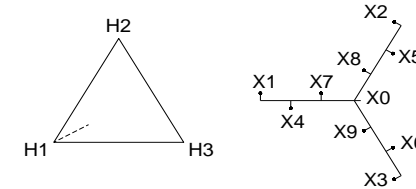

① - REMOVABLE PANELS FOR EASY ACCESS TO TERMINALS

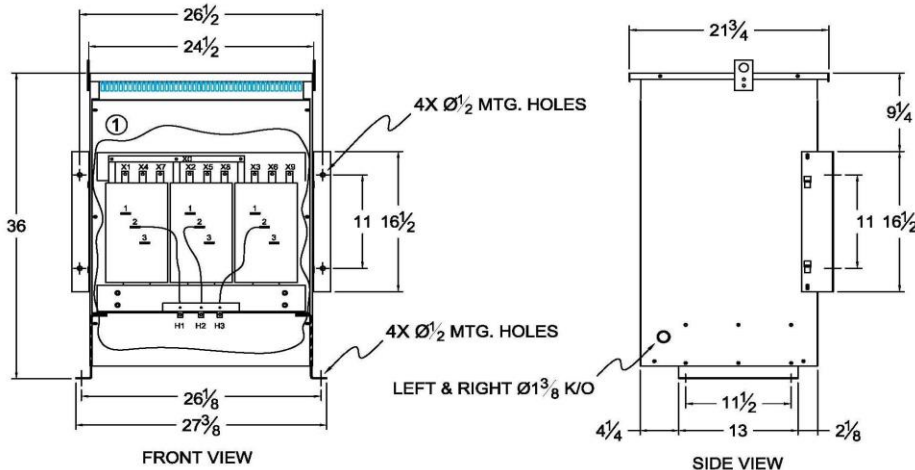

CSA Enclosure:

- 1)- Type 3R (NEMA 3R)
 - Sprinklerproof when the angle between sprinkler heads and opening in the enclosure does not exceed 45 degree from the vertical.
- 2)- Ventilated
- 3)- ASA 61 grey
- 4)- Floor/Wall mounting

Rev.	Remarks	By	Appr. By	Date
1	Height increased	AP	VS	July 29, 2019

Prepared by: AP
Approved by: VS
Date: APR.17, 2015