



TRANSFORMER SPECIFICATION

- 3 Phase Drive Isolation
- Dry Type
- ANN Self Cooled
- Suitable for Nonsinusoidal Current Load with a K-Factor not to exceed 4

Purchaser: TBA
 PO#: TBA
 SWO#: TBA
 Qty: TBA

Coils: Aluminum
 Cat. No.: DA75X-N1/FE
 RPN#: DA75HCB-N1/X/FE

kVA: 75
 Primary: 480/240/208 Delta Volts
 Secondary: 400 Y/231 Volts
 Secondary Taps: 5 %
 -Taps FCAN 1
 -Taps FCBN 1

Frequency: 60 Hz

BIL: 10 kV
 Insulation Class: 220 °C
 Temperature Rise: 150 °C
 Impedance: 4.0 - 5.0 %

Weight: 680 Lbs

Termination	Location	Lug Size
Primary:	Front	300MCM-6
Secondary:	Front	2/0-6 AWG

Wiring Connection:

Primary:	Voltage	Jumpers To:	Connect Lines To:
480	1-1-1	H1-H2-H3	
240	2-2-2	H1-H2-H3	
208	3-3-3	H1-H2-H3	

Secondary:	Voltage	% Tap	Connect Loads To:
420Y/242	105.0	X0-X7-X8-X9	
400Y/231	100.0	X0-X4-X5-X6	
380Y/220	95.0	X0-X1-X2-X3	

Note: Secondary is fully rated - only one can be used at a time

Preliminary Drawing ONLY

This drawing may NOT truly reflect our final design. Any resulting order(s) must be accompanied by or refer to this drawing and be marked with any proposed changes

Standards:

1. CSA Certified
 - File No. LR34493
2. UL Listed
 - File No. E108255

Standard Features:

1. Anti-vibration pads installed between the enclosure base and the core & coil assembly
2. Lug for Earth grounding provided
3. Neutral rated 200% of the line terminals
4. NC 200°C thermostat installed at the centre coil

Special Features:

± 5% F.C. Secondary taps

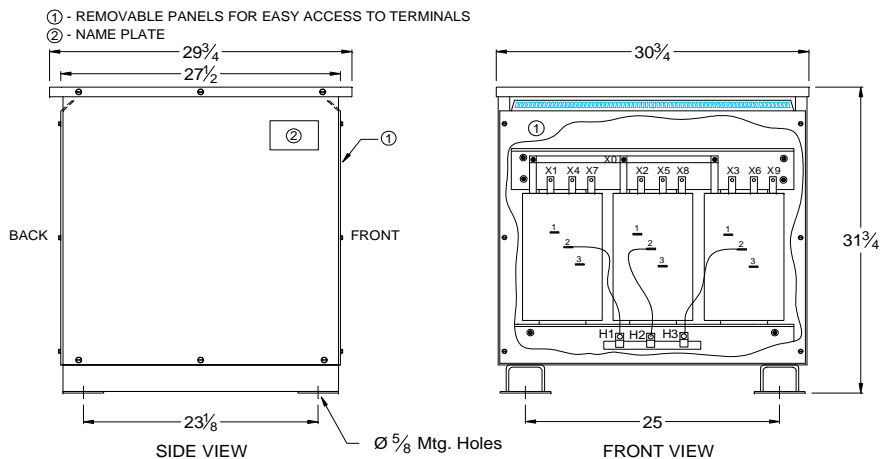
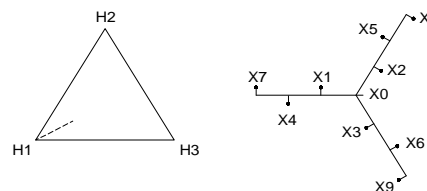

CSA Enclosure:

1. Type 3R (NEMA 3R)
 - Sprinklerproof when the angle between sprinkler heads and opening in the enclosure does not exceed 45 degree from the vertical.
2. Ventilated
3. ASA 61 grey
4. Floor mounting

Rev.	Remarks	By	Appr. By	Date

Prepared by: AP
 Approved by: VS
 Date: APR.17, 2015